

Link do produktu: <https://www.nobshop.pl/regulator-esc-foxeer-reaper-96k-65a-bl32-4in1-38s-p-3075.html>

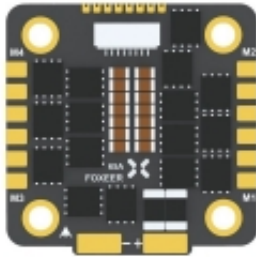

## Regulator ESC Foxeer Reaper 96K 65A BL32 4in1 3~8S

Cena brutto	<b>579,00 zł</b>
Cena netto	<b>470,73 zł</b>
Dostępność	<b>Aktualnie niedostępny</b>
Czas wysyłki	<b>1 - 3 dni</b>
Producent	<b>Foxeer</b>

### Opis produktu

#### Regulator ESC Foxeer Reaper 96K 65A BL32 4in1 3~8S

Firmware	FOXEEER_Reaper_4IN1_65A_96_Multi_32_8
Continuous /Burst Current	65A*4 / 100A*4
Input Voltage	DC 10V~35V (3-8S Lipo)
BEC	No
Telemetry	Supported
ESC Programming	BLHeli32
Input Signal	DShot 150/ 300/ 600/ 1200 /MultiShot/ OneShot etc.
Working Temperature	-20°C ~ +55°C
Working Humidity	20~95%
Storage Temperature	-20°C ~ +70°C
Mounting Hole	30.5X30.5mm,Φ4mm/M3
Dimension	42.5x42x5.5mm
Weight	14.8g

**96K**  
**REAPER**  
**65A**

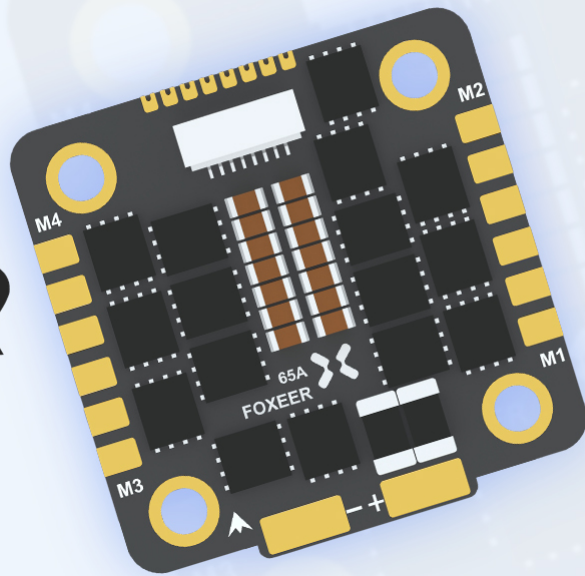

65A Persistent/100A Peak

High Quality Import Mosfet

Excellent Layout

Low Heat

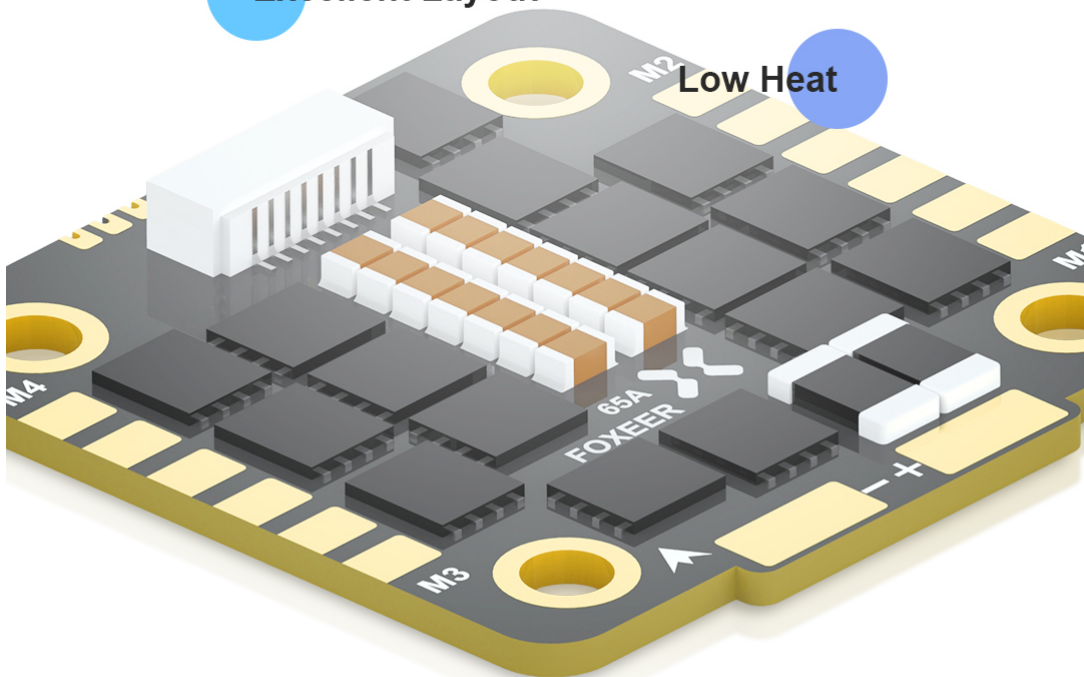

# Desync Improvement

Excellent circuit design helps to improve desync issue

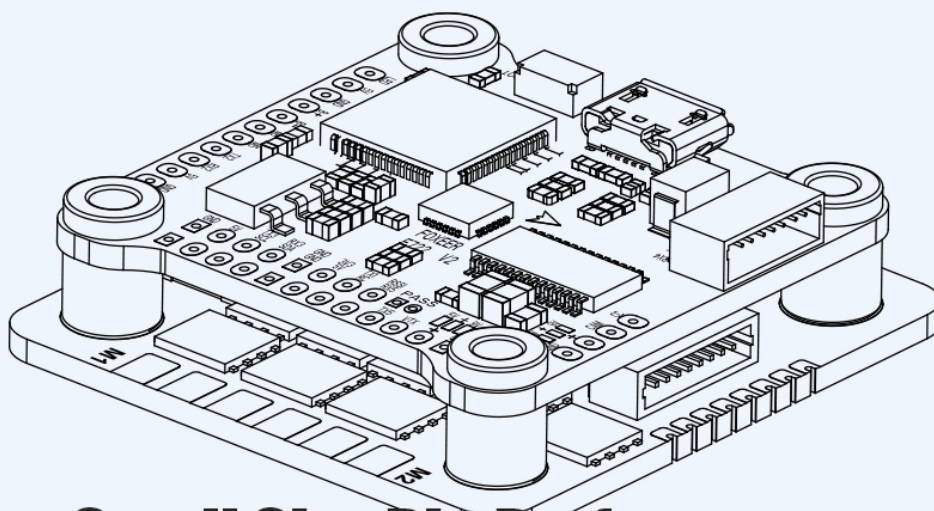
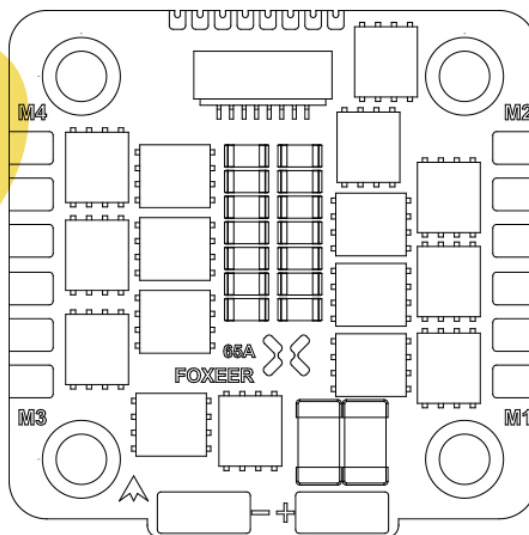

## Small Size Big Performance

Well built quality guarantee system durability.  
Plug & Play with Foxeer F722 to enjoy super smooth flying experience.

## 3S-8S Lipo

Excellent power design supports input voltage up to 35V(8S).

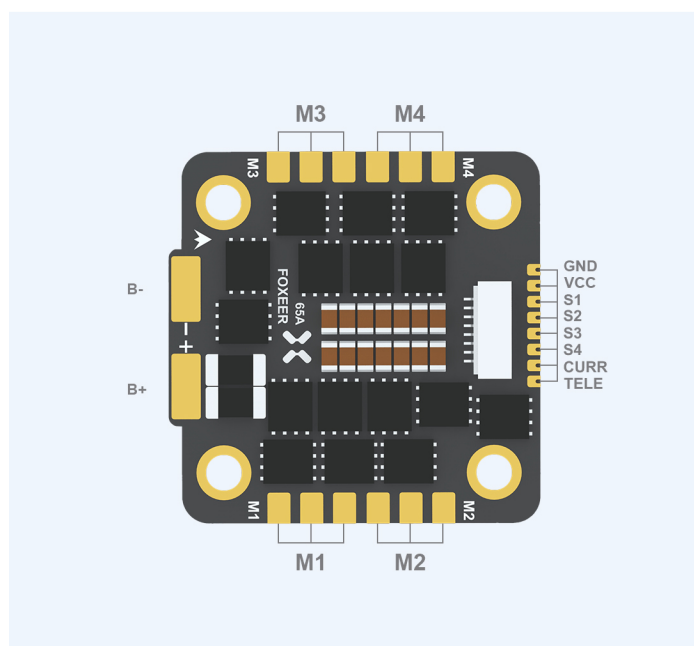
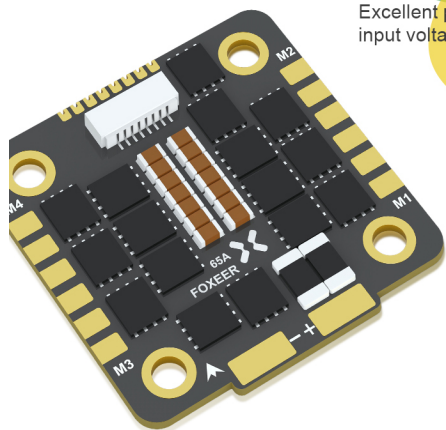

Unit of length: mm

