

Link do produktu: <https://www.nobshop.pl/kamera-fpv-foxeer-mini-cat-3-1200tv1-000001lux-starlight-p-2932.html>



## Kamera FPV Foxeer Mini Cat 3 1200TVL 0.00001Lux StarLight

Cena brutto	<b>209,00 zł</b>
Cena netto	<b>169,92 zł</b>
Dostępność	<b>Aktualnie niedostępny</b>
Czas wysyłki	<b>1 - 3 dni</b>
Kod producenta	<b>HS1259</b>
Producent	<b>Foxeer</b>

### Opis produktu

Sensor Type	Sony 1/3" CMOS Sensor
Scale	4:3(Default)/16:9 Switchable
Tv System	PAL(Default)/NTSC Switchable
Resolution	1200TVL
Lens	M12 2.1mm Low Light Lens
FOV	4:3 FOV-H: 100° FOV-D:125° 16:9 FOV-H: 100° FOV-D:115°
Shutter Speed	PAL 1/25~1/10000 sec; NTSC 1/30~1/10000 sec
Video Output	CVBS Analog Signal
Minimum Illumination	0.00001Lux
White Balance	Auto
DNR	3DNR
WDR	100dB
DAY/NIGHT	EXT/Auto/Color/B&W
Flight OSD	Voltage/Cam Title/Time
Input Voltage	4.6V~20V
Language	ENGLISH / 中文 / PYCCKNN / ESPANOL / ITALIANO / FRANCAIS/POLSKIM/ PORTUGUES / русский / EAAHNIKA
Working Temperature	-10°~50°C RH90% MAX
Working Humidity	20~80%
Storage Temperature	-20°~70°C
Consumption	95mA±15% @ DC12V
Dimension	22*22mm; 28*22(with Bracket)
Weight	12.2g(Exclude cable)



• Less Noise • Low Latency • 0.00001LUX Super Starlight

# FOXEEER CAT 3 MINI

**Exclusive Optimization for LED**





4:3/16:9 & PAL/NTSC  
Switchable

16:9 FOV-H 100° FOV-D 115°  
4:3 FOV-H 100° FOV-D 125°

## Large Aperture Night Vision Lens

## Support OSD & Menu Remote Control With Foxeer FC

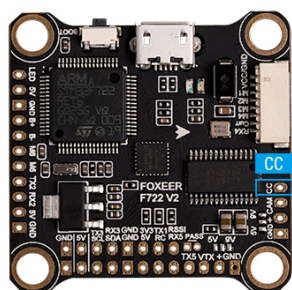

Camera Control

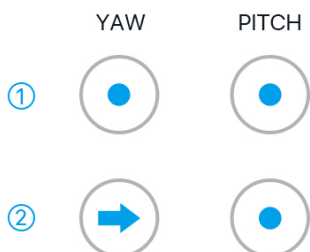





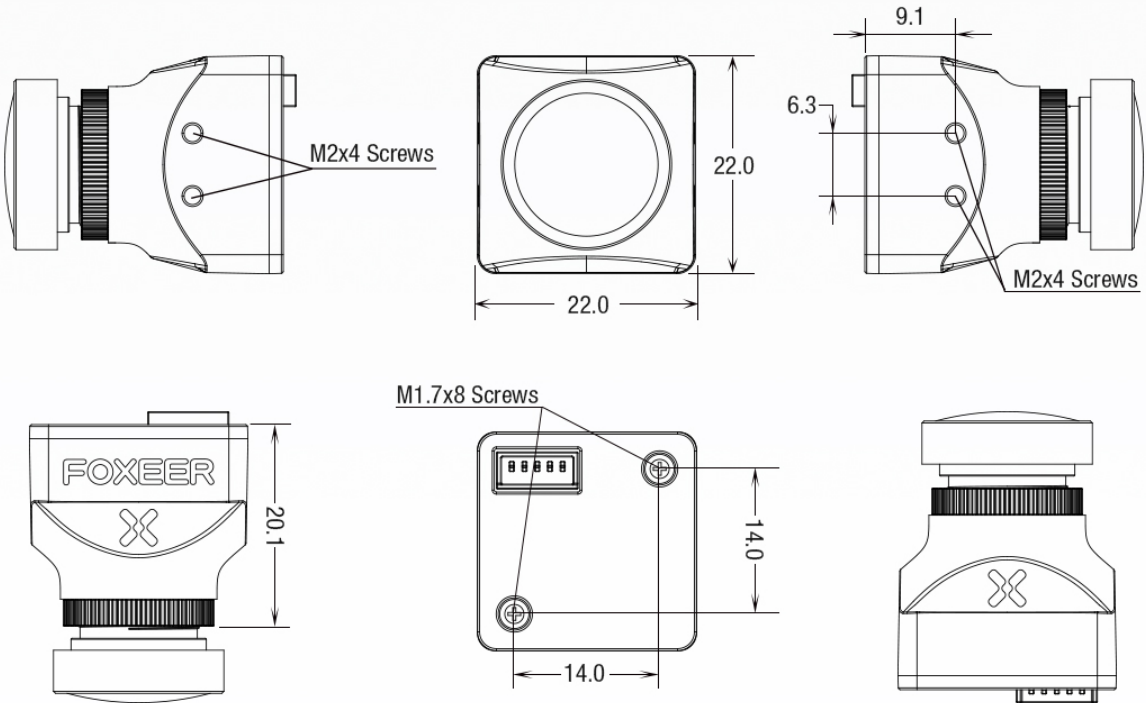

Access the Camera Setting Menu



Unit of length: mm



	<p>1 x Foxeer Cat Mini camera</p>		<p>12 x Bracket Screws 6 x Gasket Ring</p>
	<p>1 x OSD Board</p>		<p>1 x 2pin OSD Cable</p>
	<p>1 x Bracket</p>		<p>1 x Servo Cable</p>

---

Produkt posiada dodatkowe opcje:

**Kolor:** Czarny